

1 = 0  
2 = 0

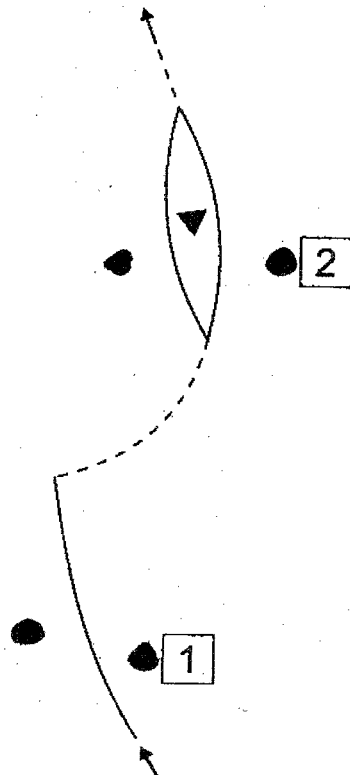

1 = 0  
2 = 0

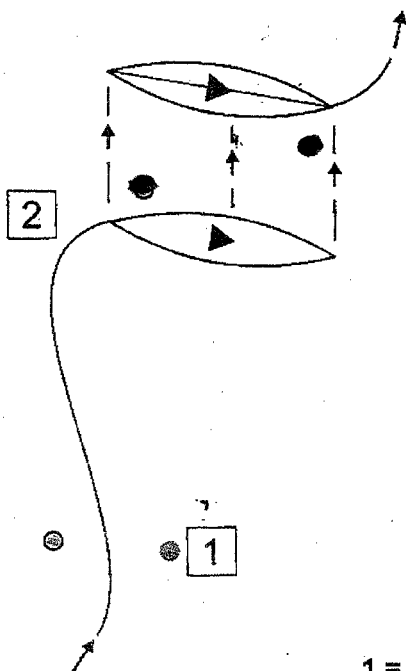

1 = 0  
2 = 0

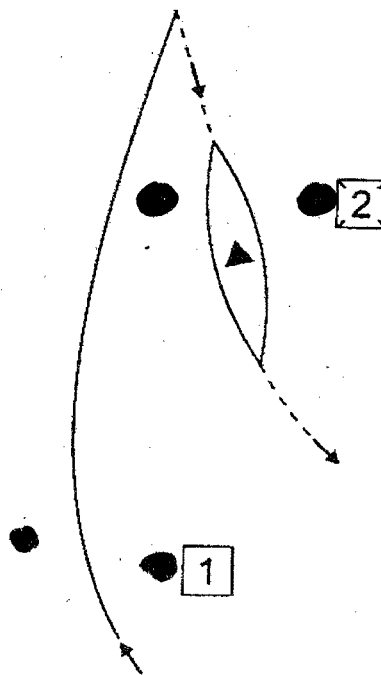

1 = 0  
2 = 0

5 

6 

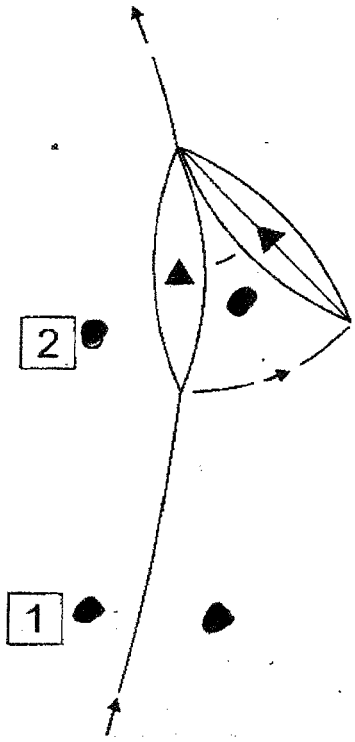

1 = 0  
2 = 0

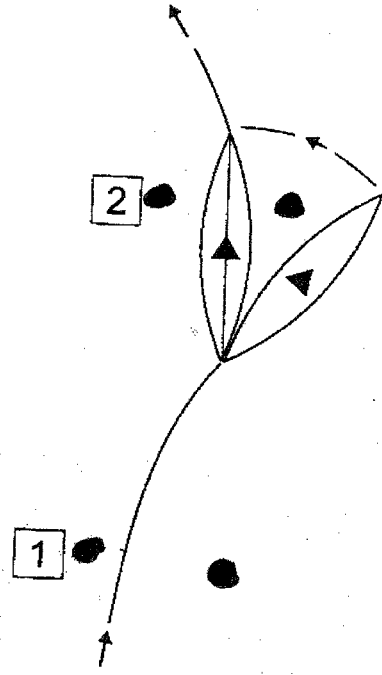

1 = 0  
2 = 0

7 

8 

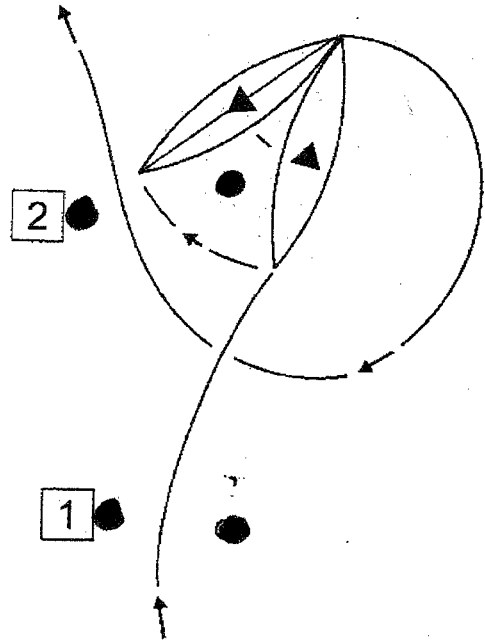

1 = 0  
2 = 0

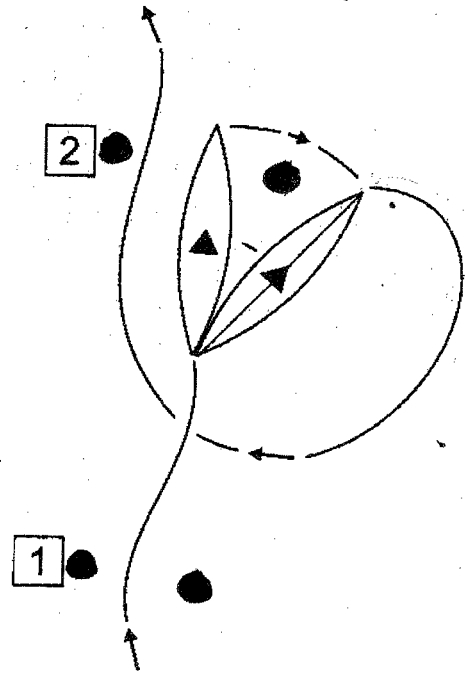

1 = 0  
2 = 0



9

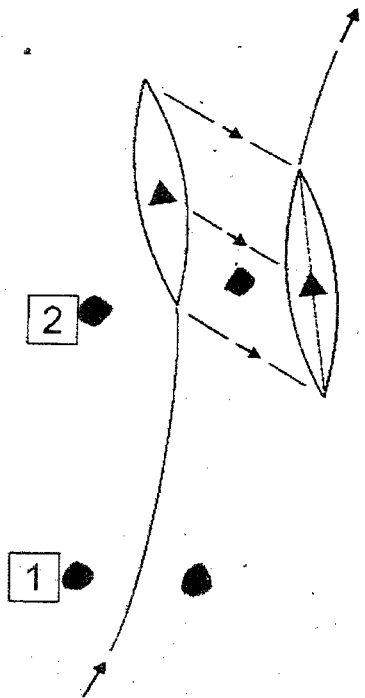

1=0  
2=0



10

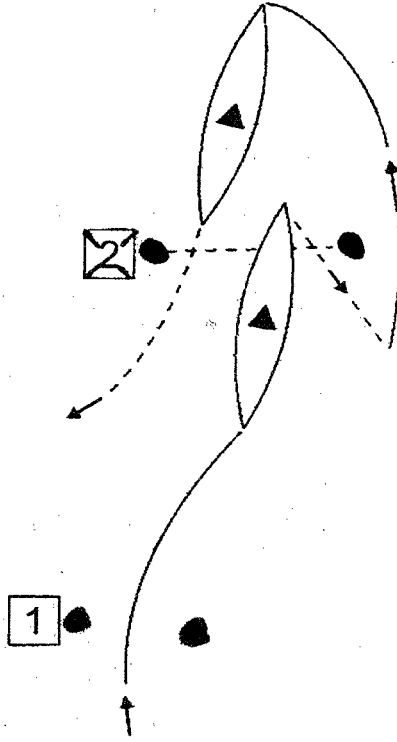

1=0  
2=0



11

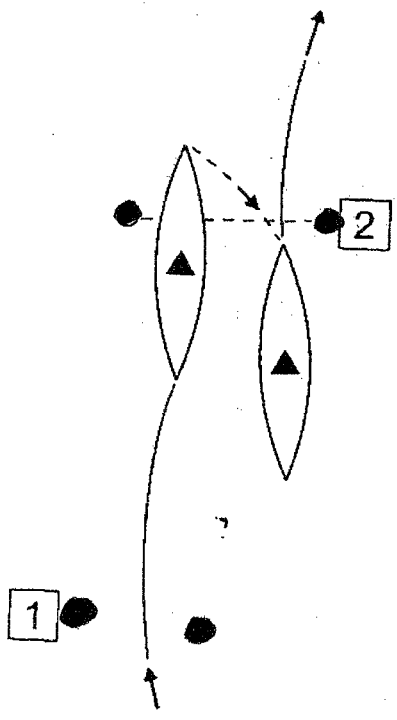

1=0  
2=0



12

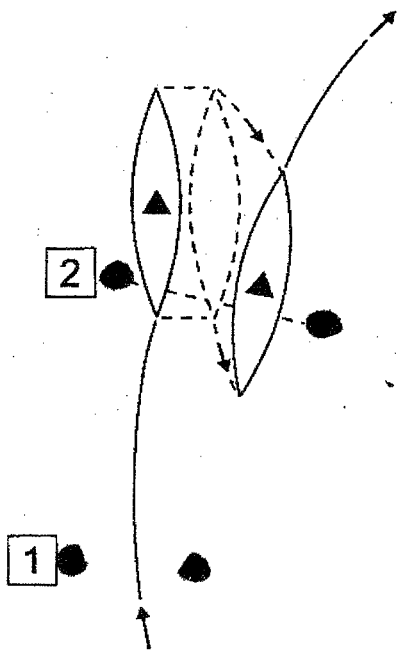

1=0  
2=0



13

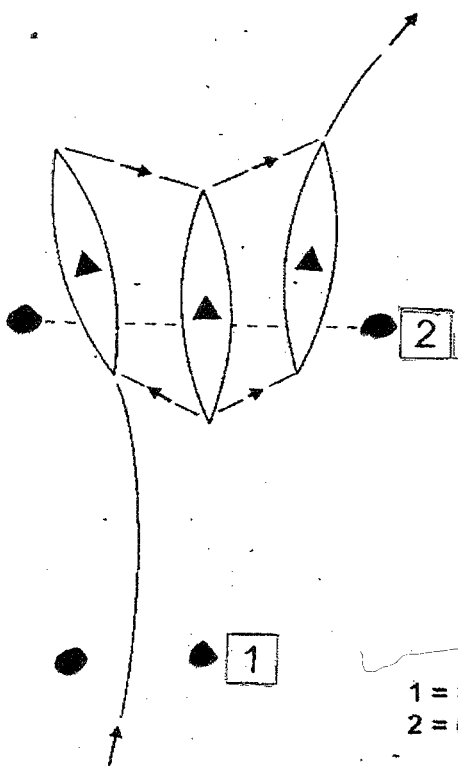

14

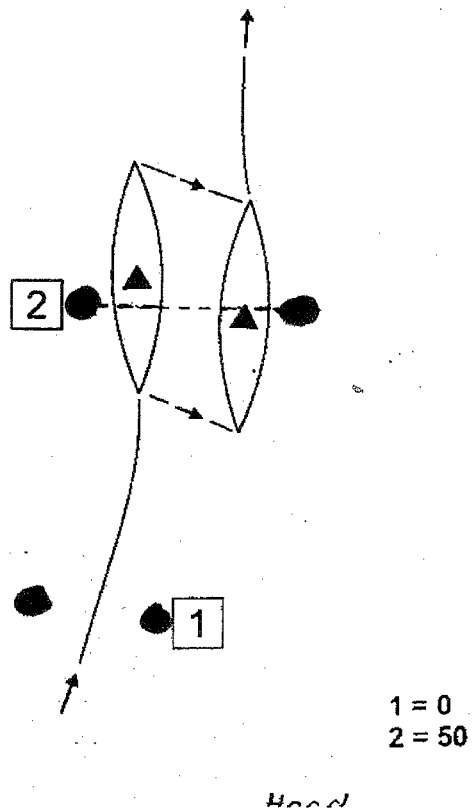

15

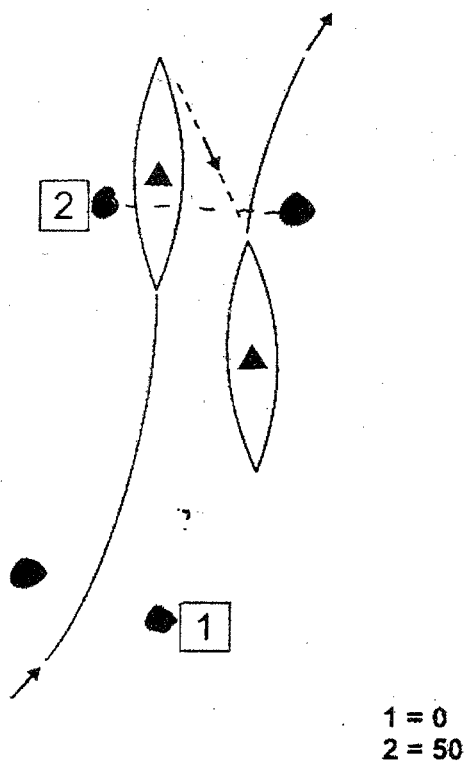

16

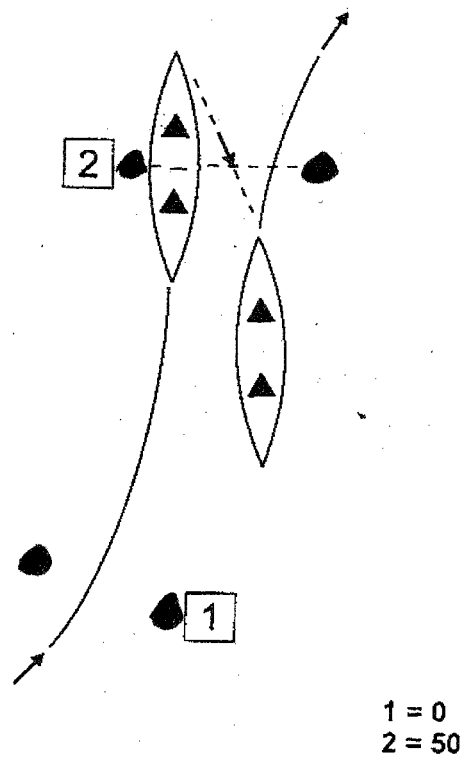



17

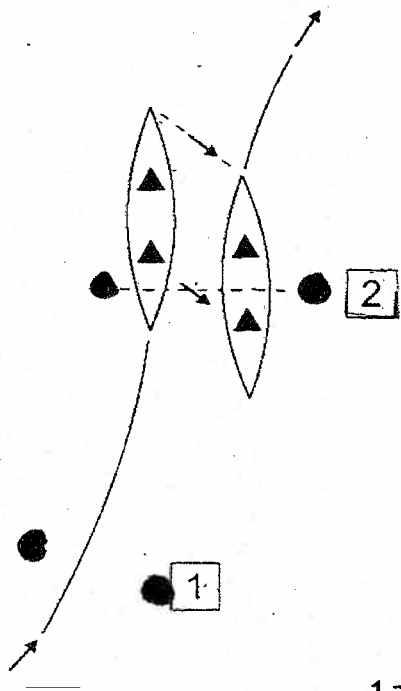

1 = 0  
2 = 50



18

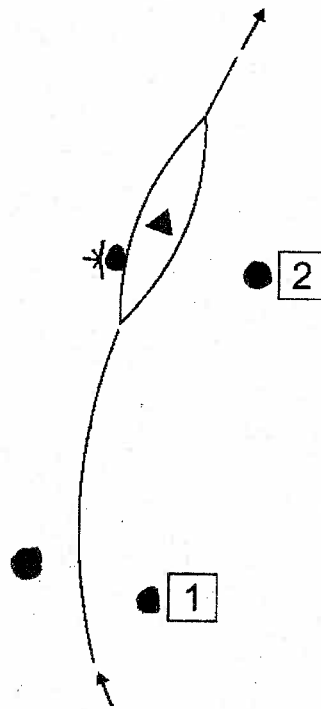

1 = 0  
2 = 2



19

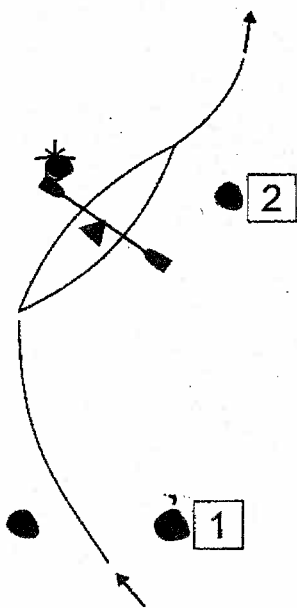

1 = 0  
2 = 2



20

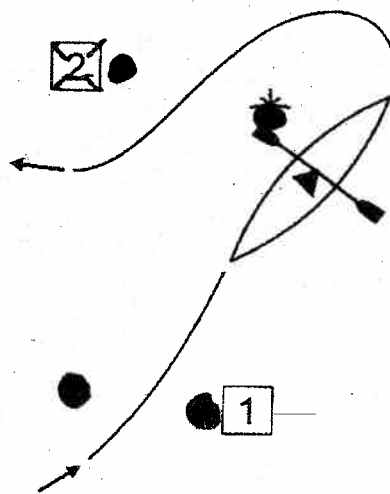

1 = 0  
2 = 2

21 

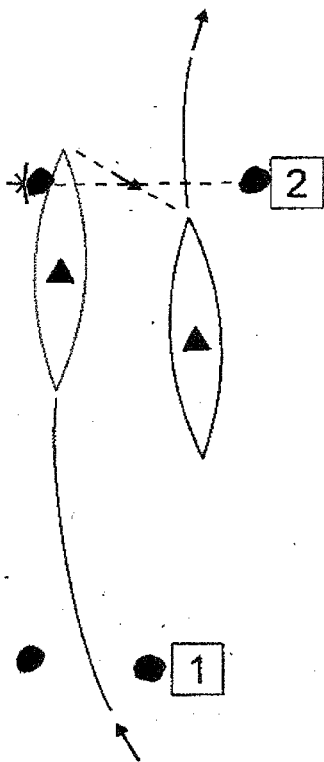

1 = 0  
2 = 2

22 

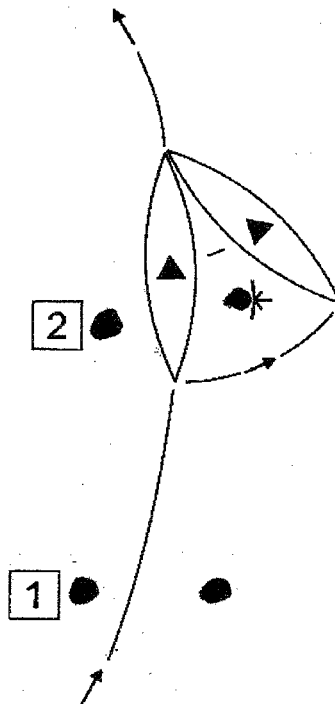

1 = 0  
2 = 2

23 

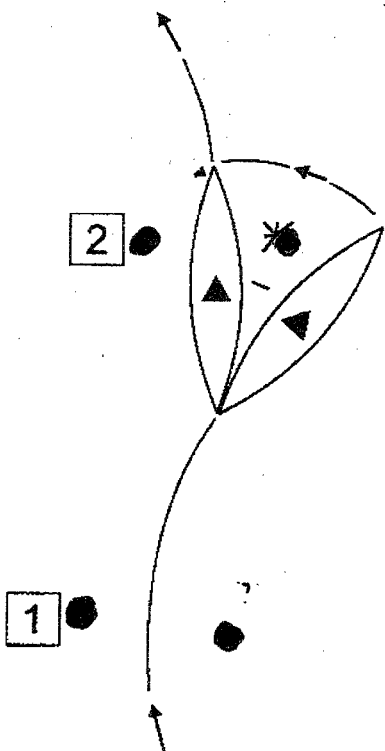

1 = 0  
2 = 2

24 

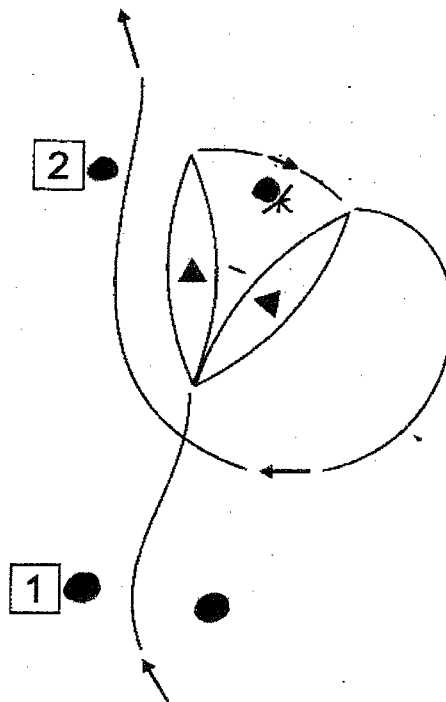

1 = 0  
2 = 2



25

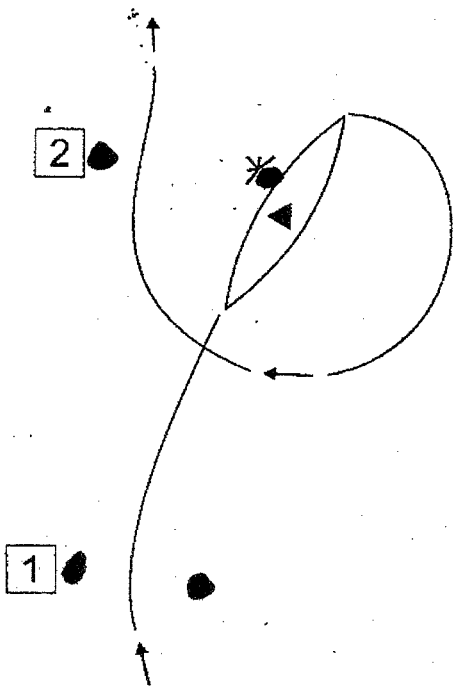

1 = 0  
2 = 2



26

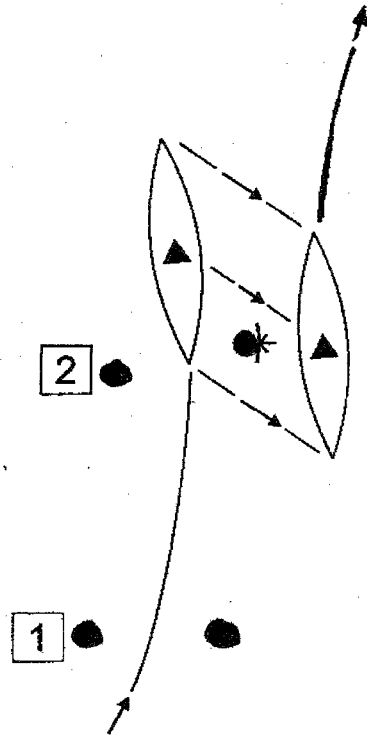

1 = 0  
2 = 2



27

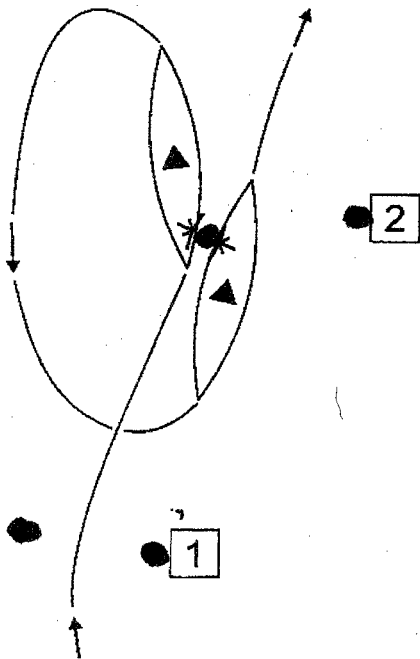

1 = 0  
2 = 2



28

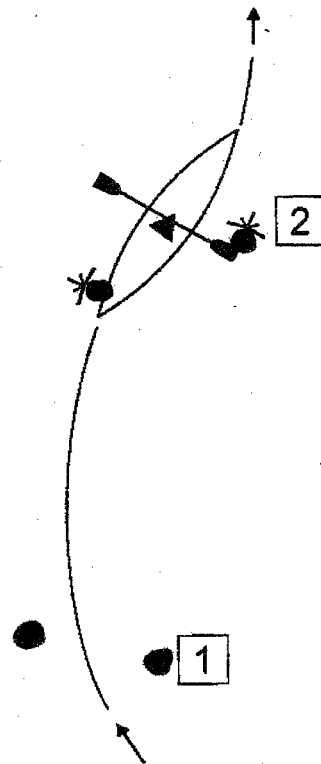

1 = 0  
2 = 2

29

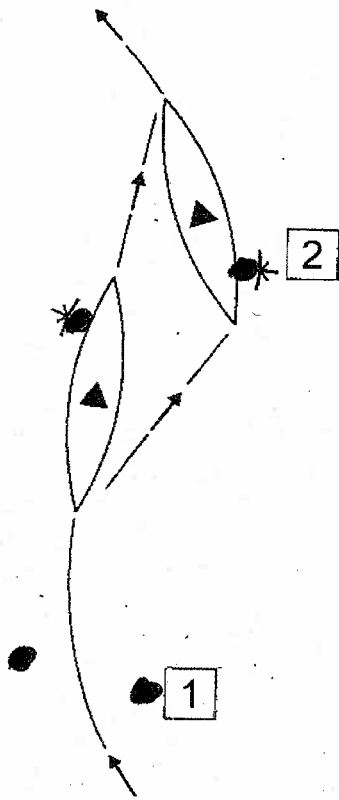

1=0  
2=2

30

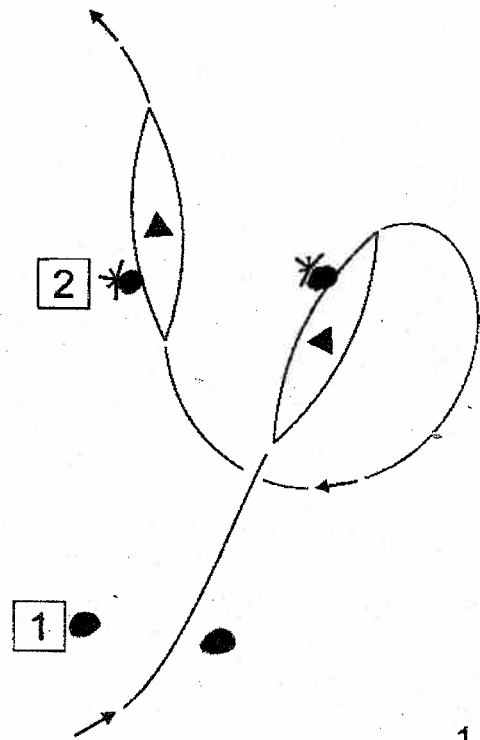

1=0  
2=2

31

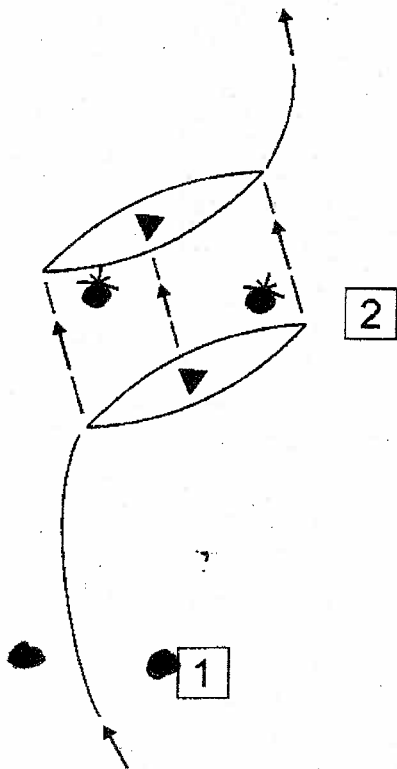

1=0  
2=2

32

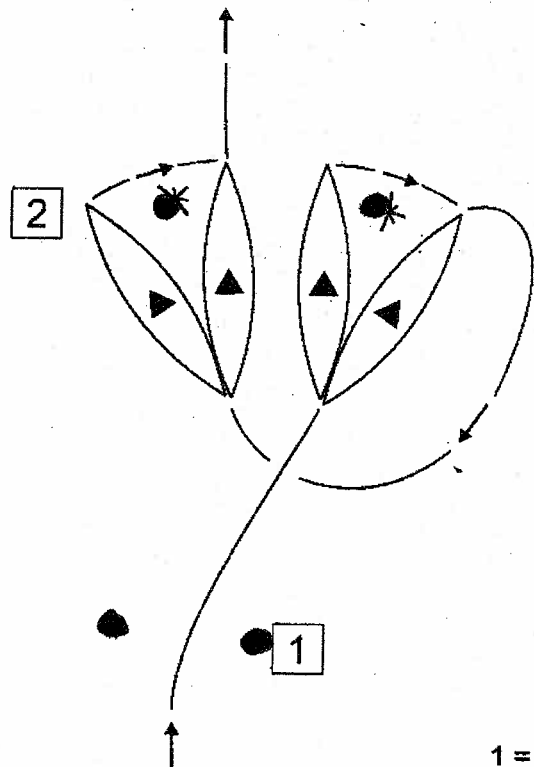

1=0  
2=2



33



34

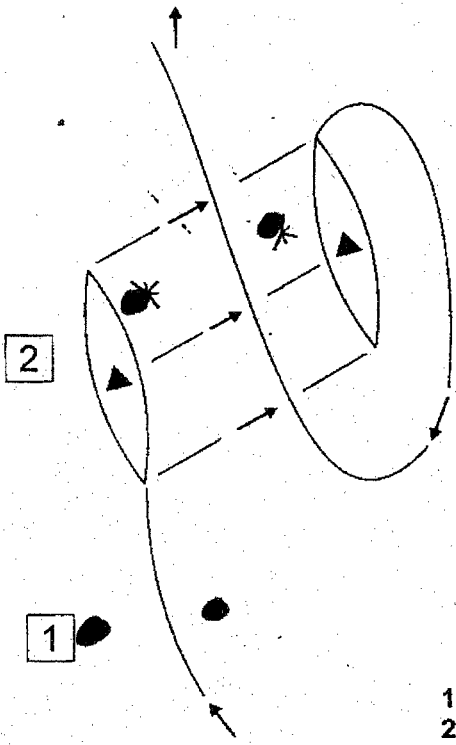

1 = 0  
2 = 2

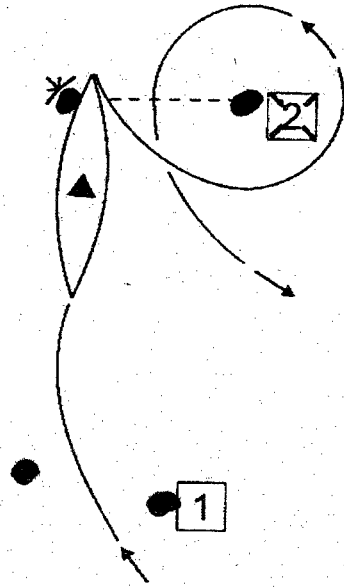

1 = 0  
2 = 2



35



36

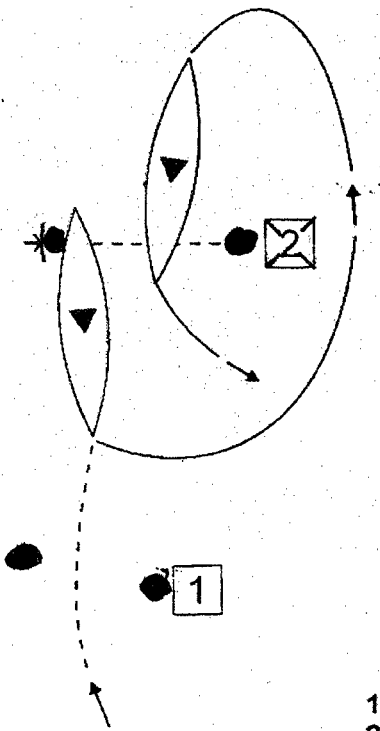

1 = 0  
2 = 2

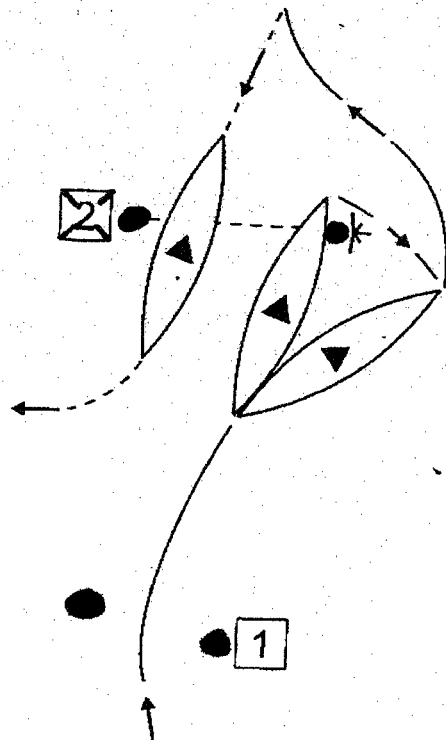

1 = 0  
2 = 2

37 

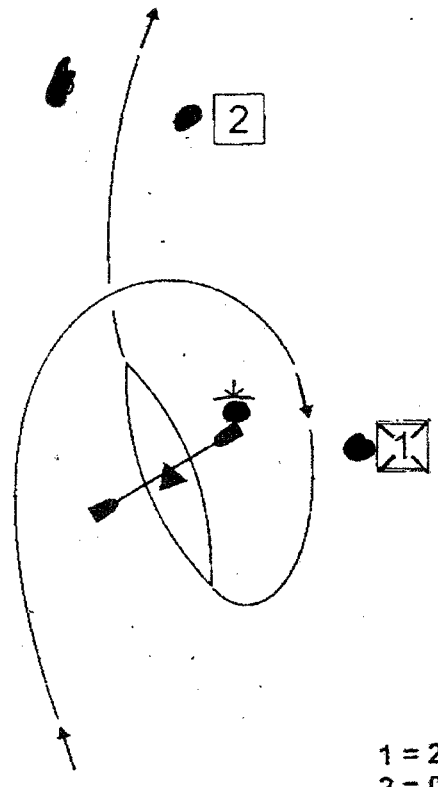

1 = 2  
2 = 0

38 

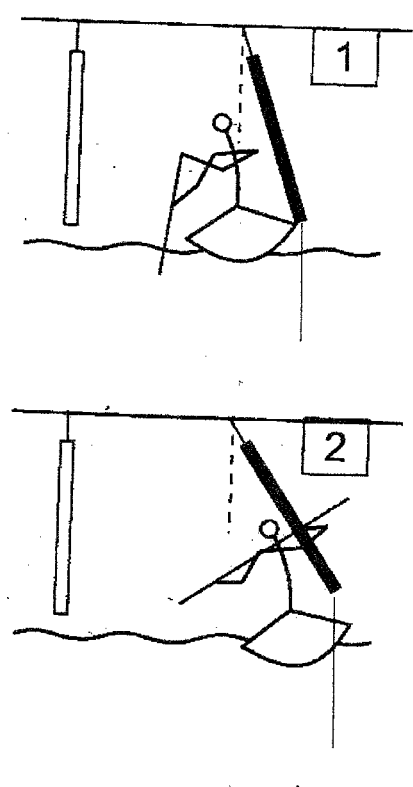

1 = 2  
2 = 2

39 

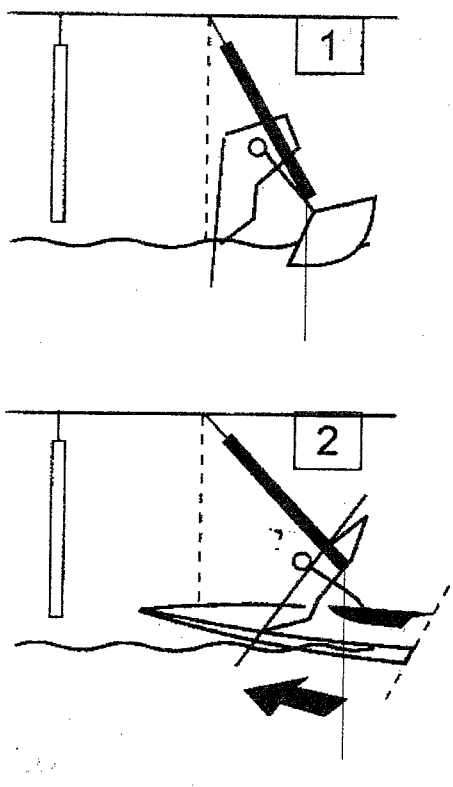

1 = 2  
2 = 2

39-1 

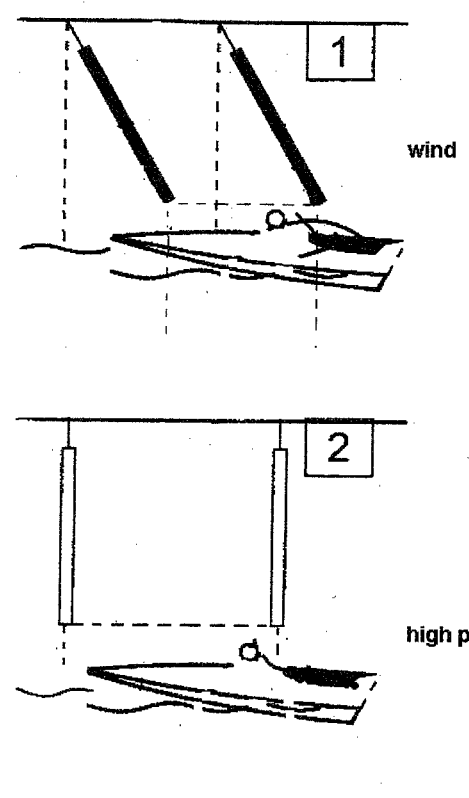

1 = 0  
2 = 0

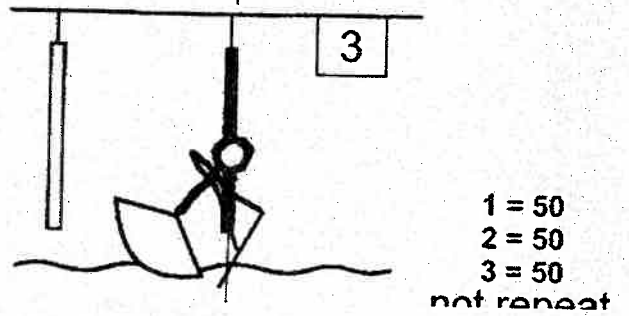
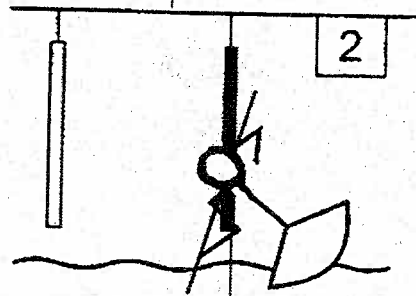
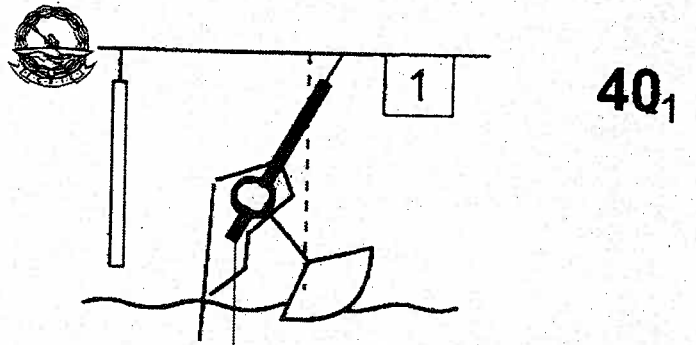
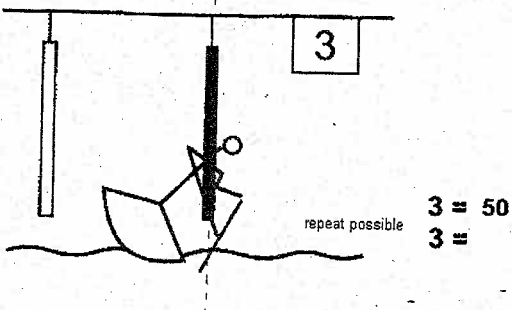
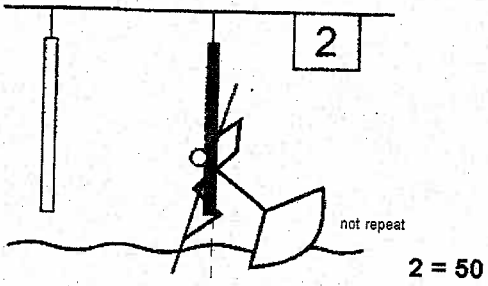
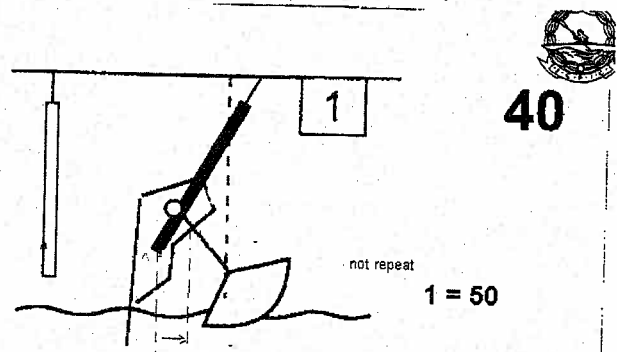

40-2

41

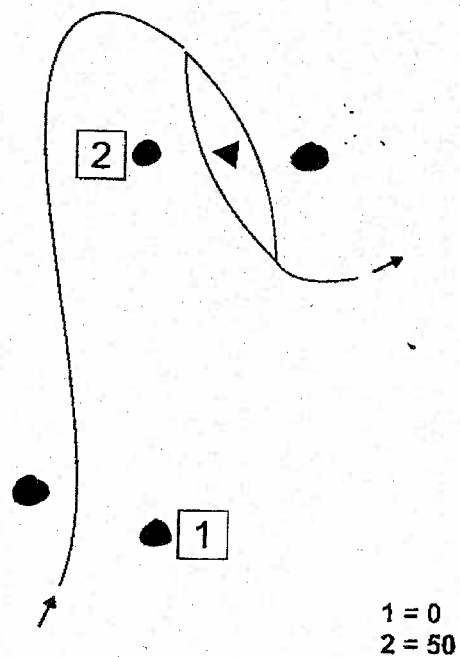
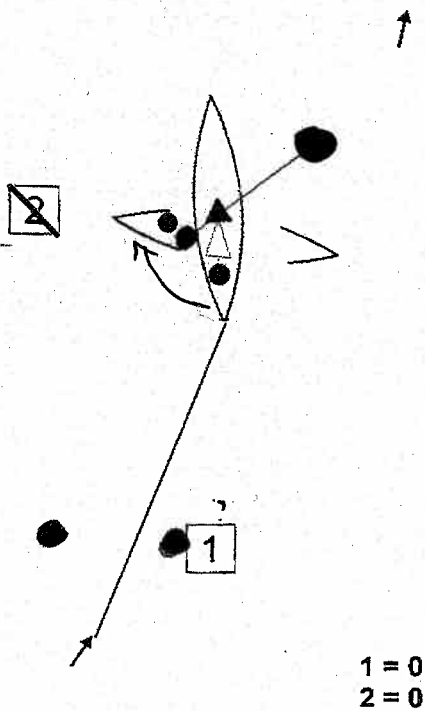

42

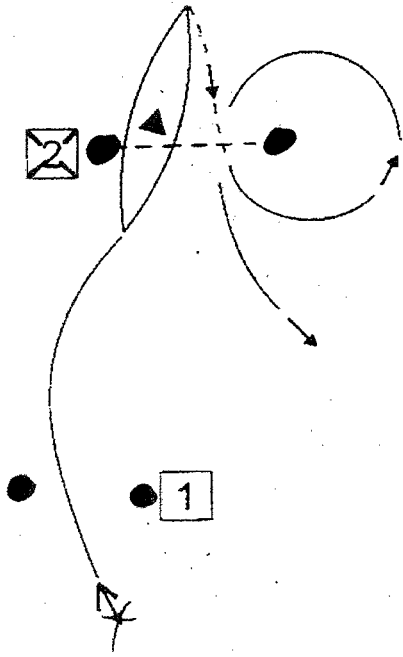

1 = 0  
2 = 50

43

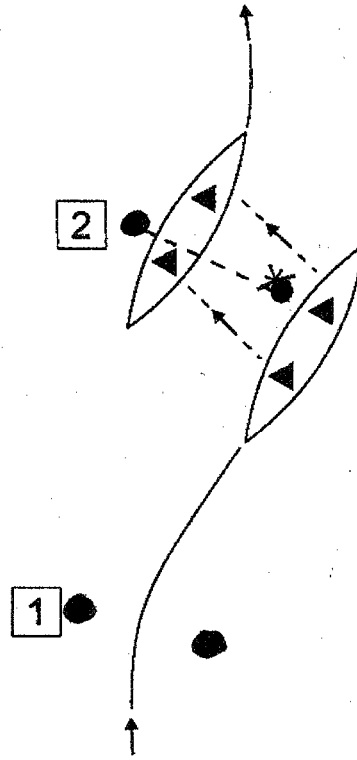

1 = 0  
2 = 50

44

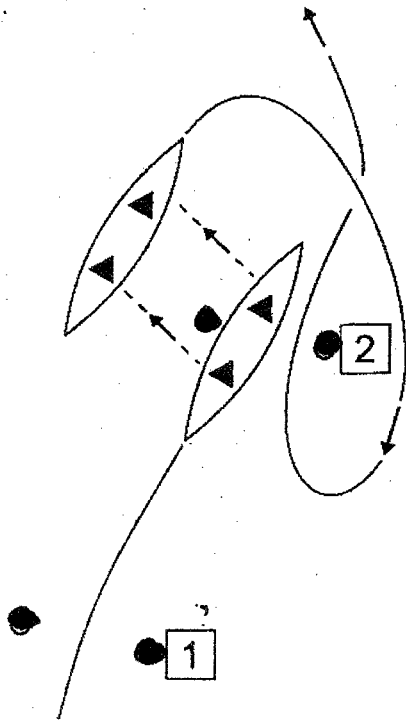

1 = 0  
2 = 50

45

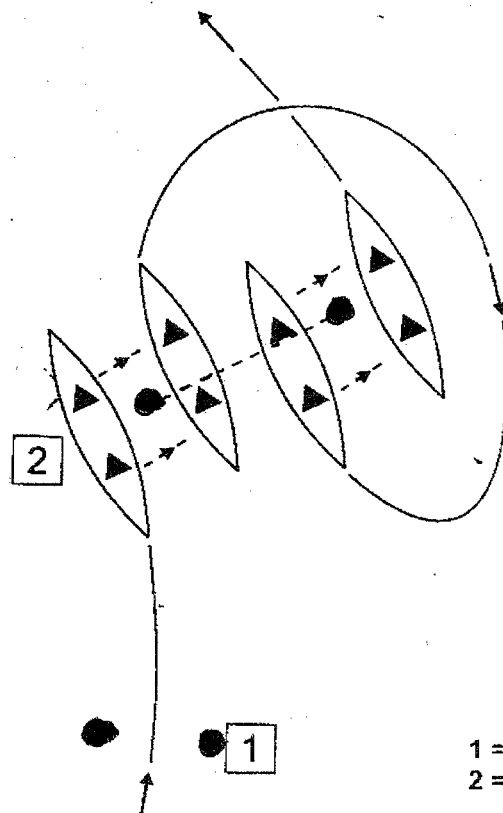

1 = 0  
2 = 50



46

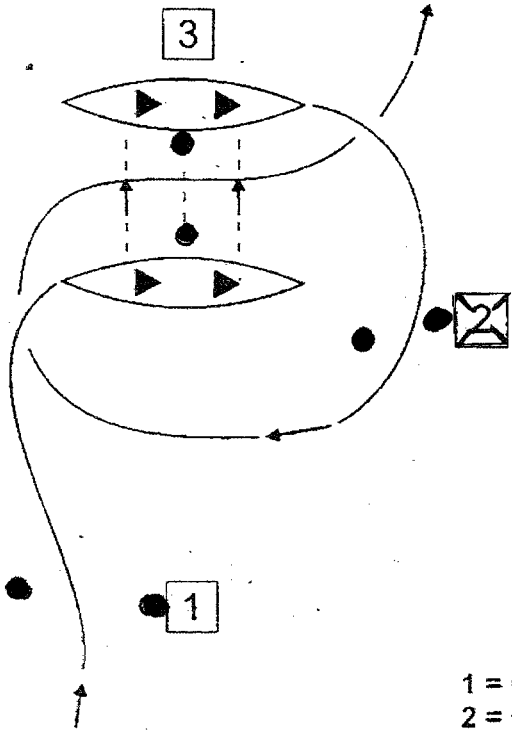

1 = 0  
 2 = 0  
 3 = 0



47

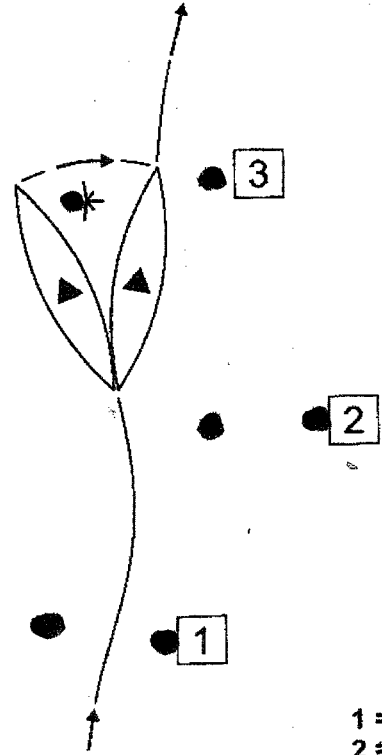

1 = 0  
 2 = 50  
 3 = 2



48

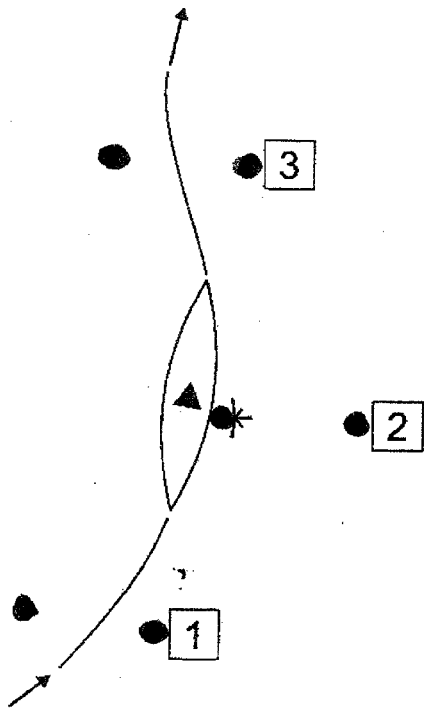

1 = 0  
 2 = 50  
 3 = 0



49

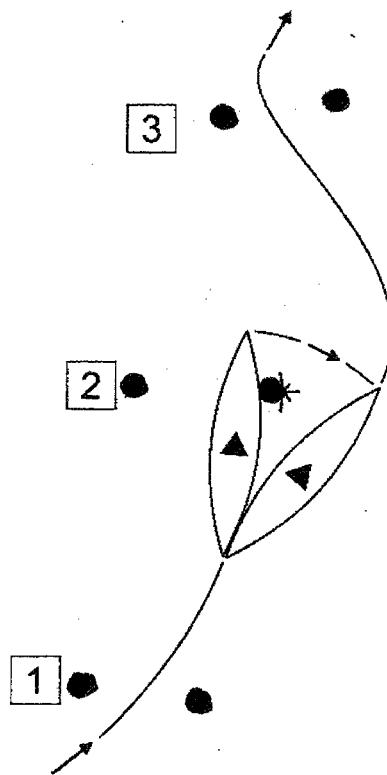

1 = 0  
 2 = 50  
 3 = 0

50 

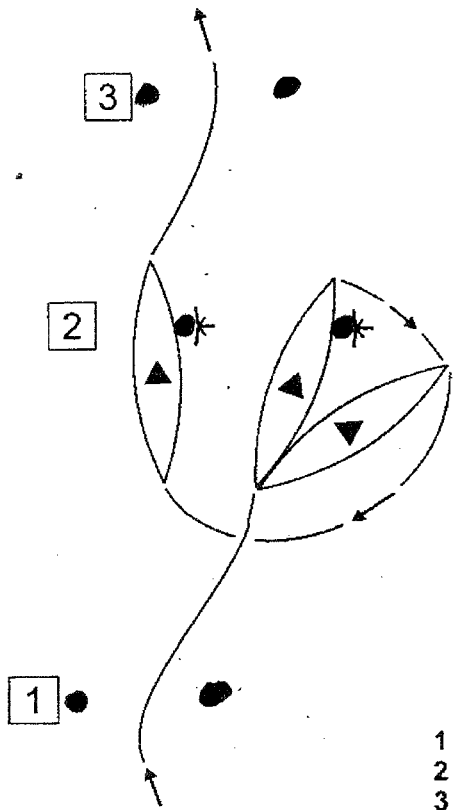

1 = 0  
2 = 50  
3 = 0

51 

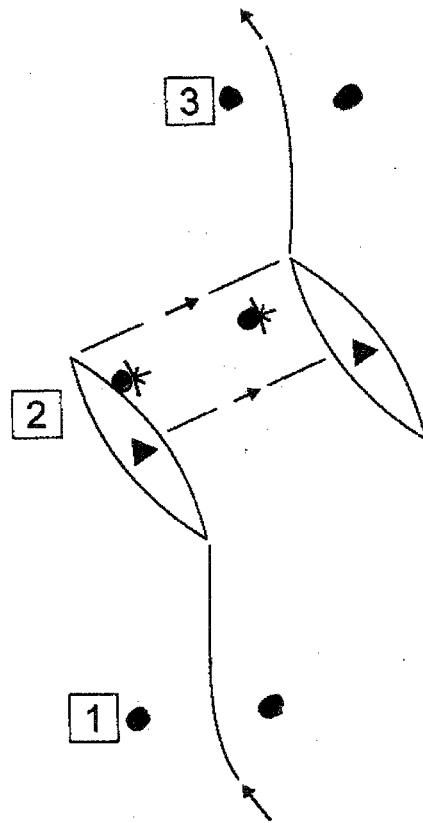

1 = 0  
2 = 50  
3 = 0



52

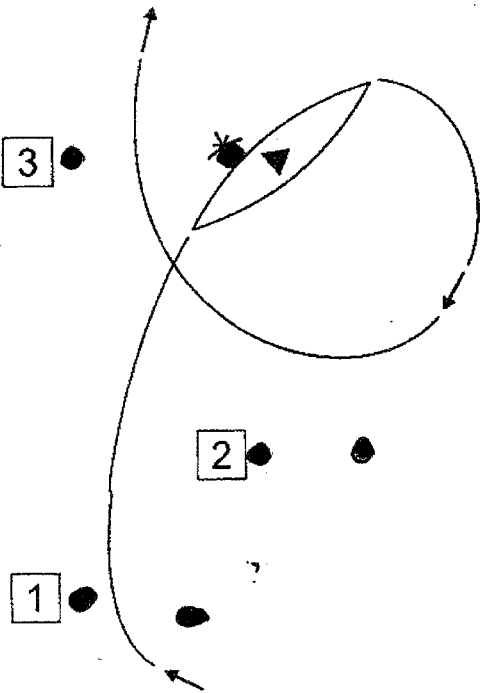

1 = 0  
2 = 50  
3 = 2

53 

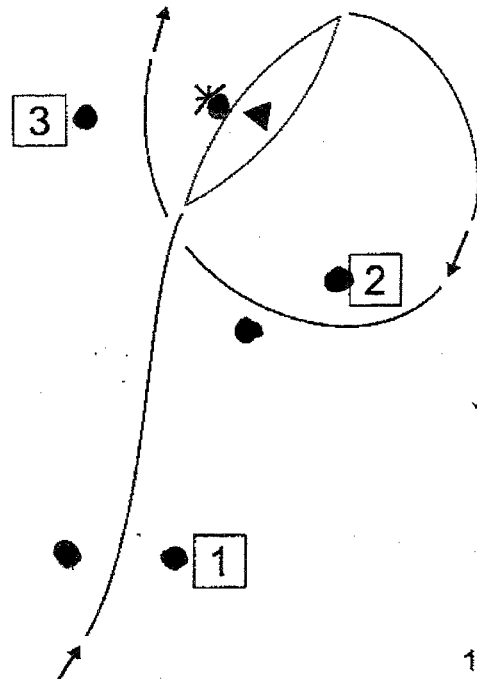

1 = 0  
2 = 50  
3 = 2



54



55

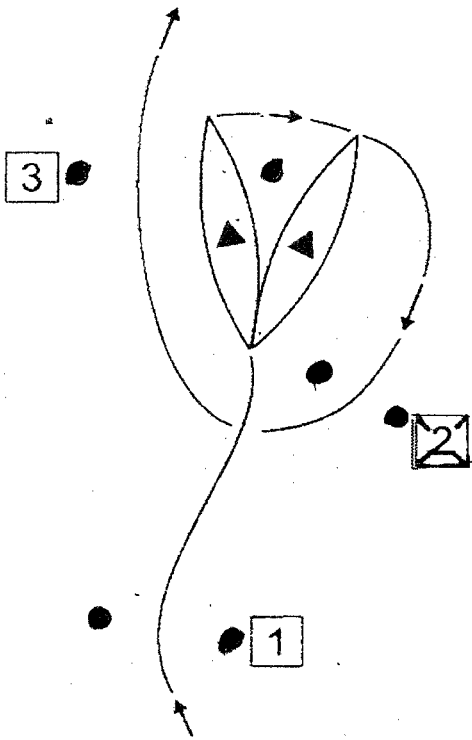

1 = 0  
 2 = 0  
 3 = 0

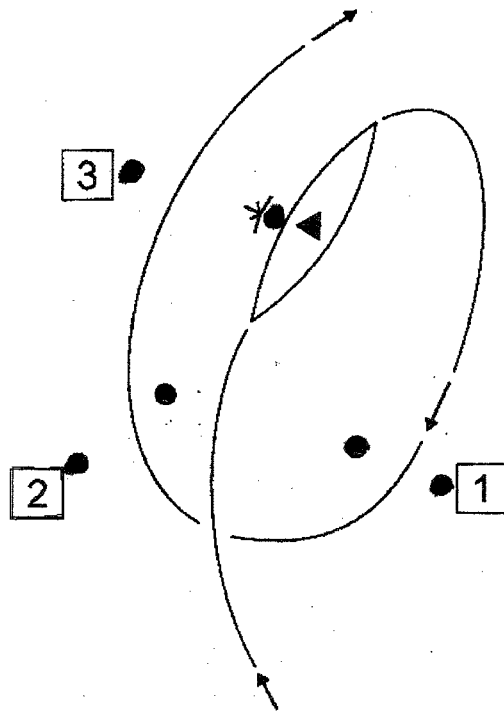

1 = 50  
 2 = 50  
 3 = 2



56



57

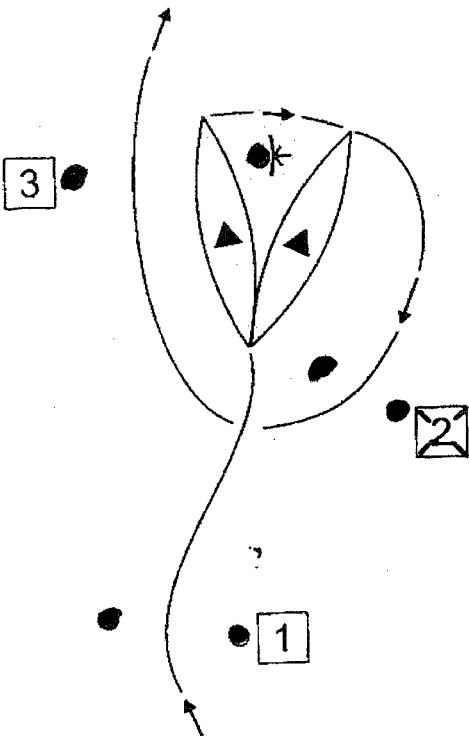

1 = 0  
 2 = 50  
 3 = 2

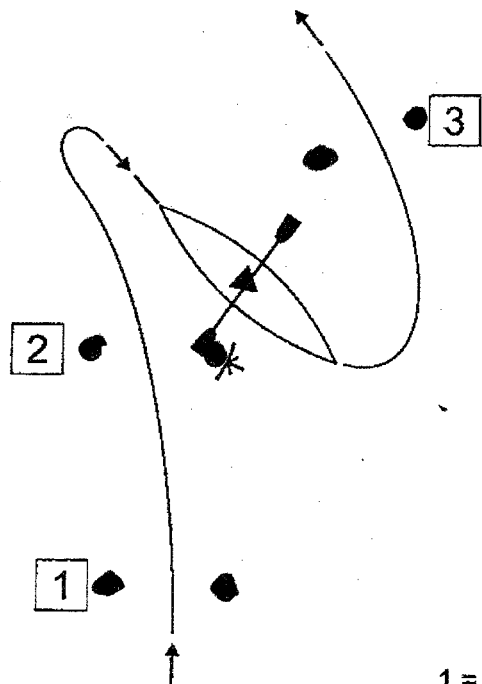

1 = 0  
 2 = 2  
 3 = 0

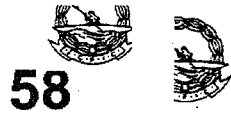

58

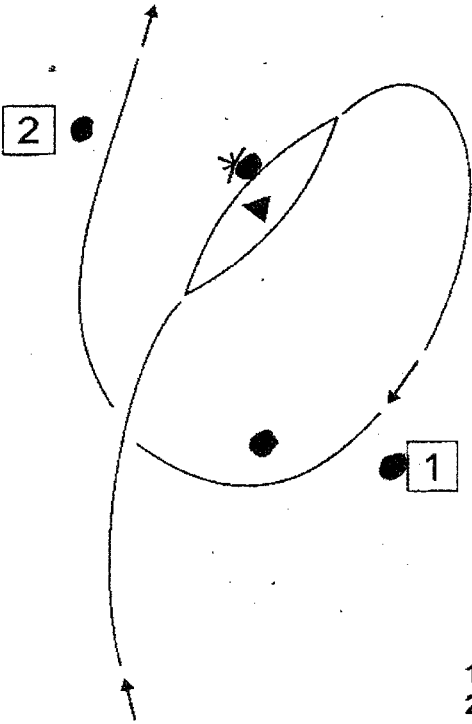

1 = 50  
2 = 2

59

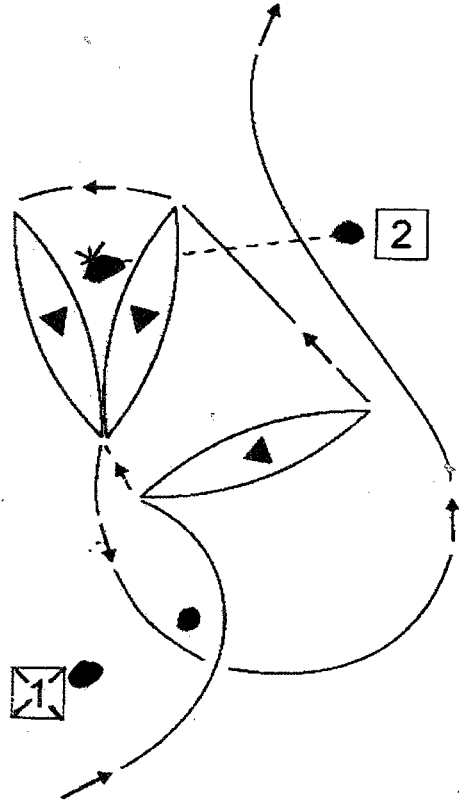

1 = 50  
2 = 2



60

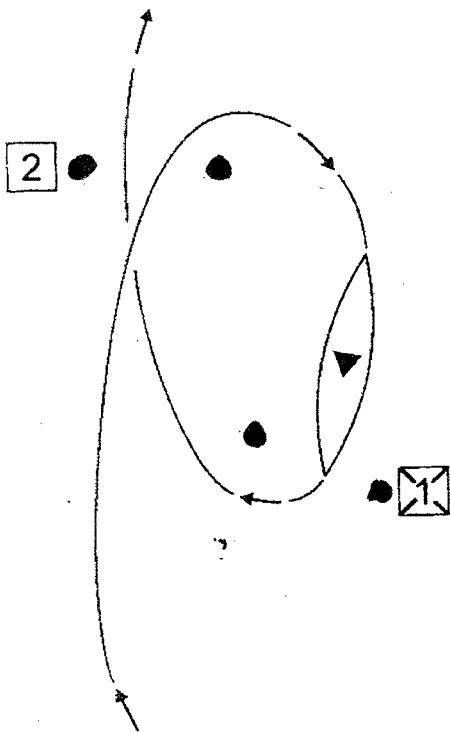

1 = 50  
2 = 0

61

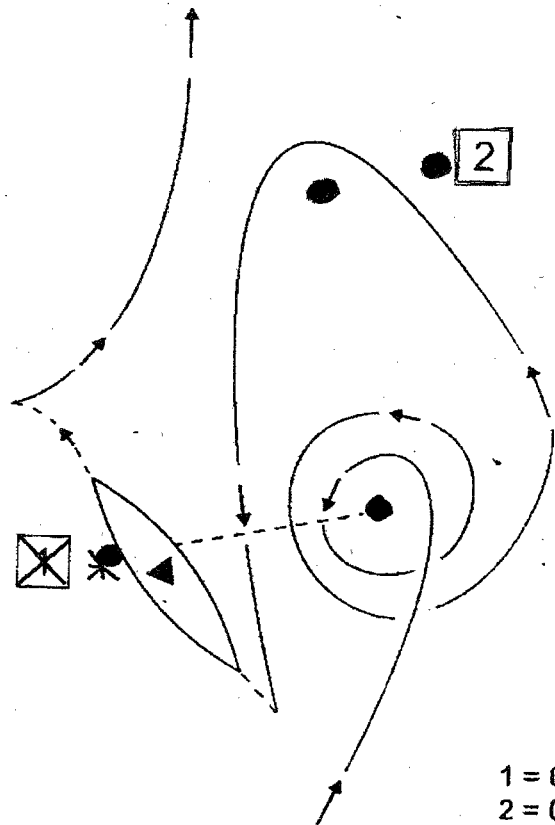

1 = 0  
2 = 0





62



63

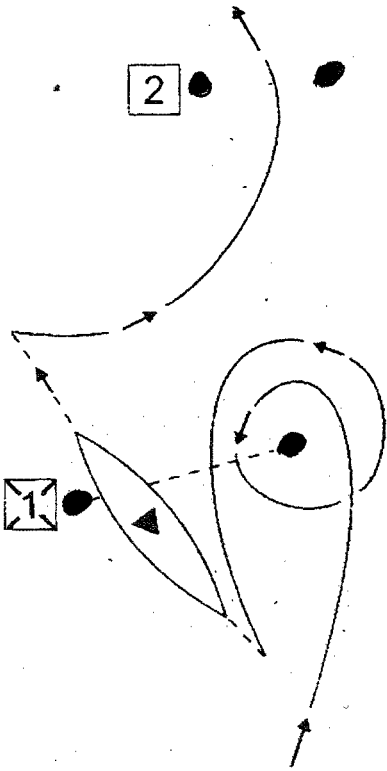

1 = 50  
2 = 0

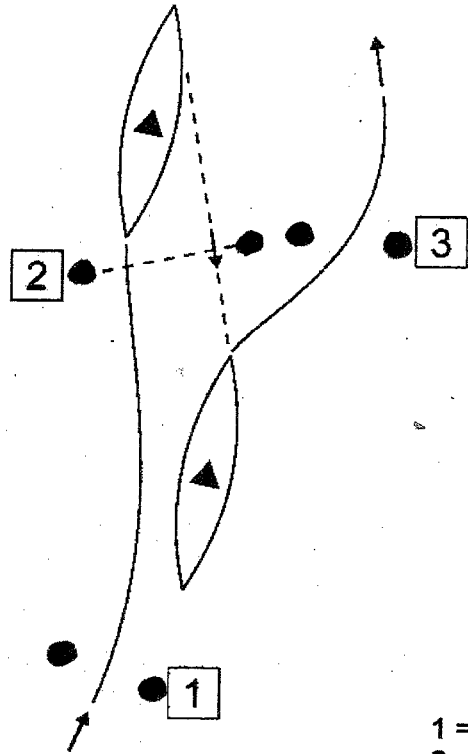

1 = 0  
2 = 50  
3 = 0

64



65

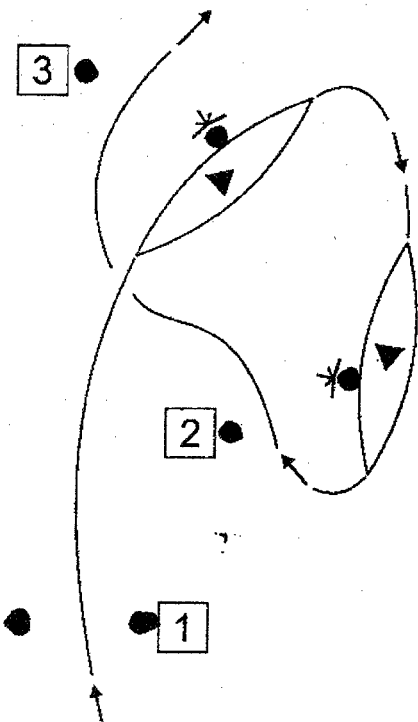

1 = 0  
2 = 50  
3 = 2

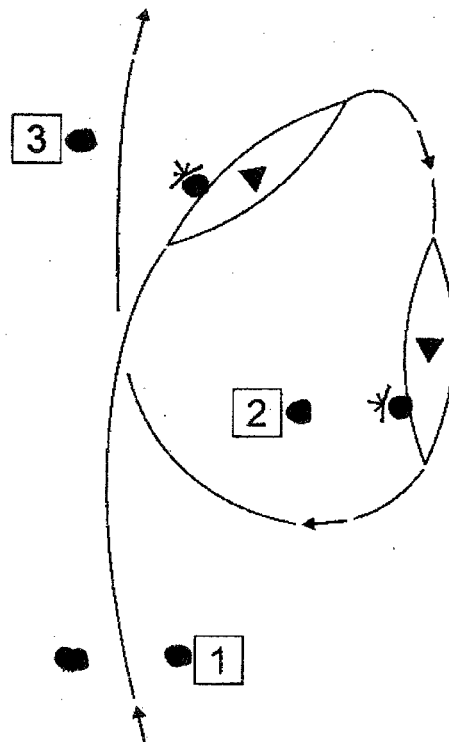

1 = 0  
2 = 50  
3 = 2



66

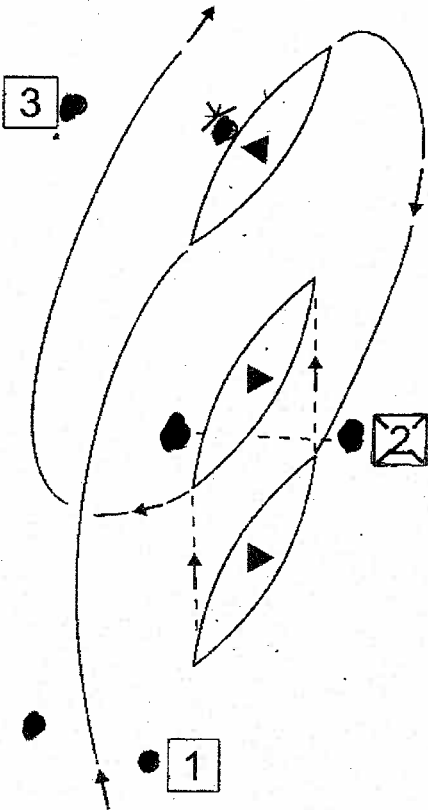

1 = 0  
 2 = 50  
 3 = 2



67

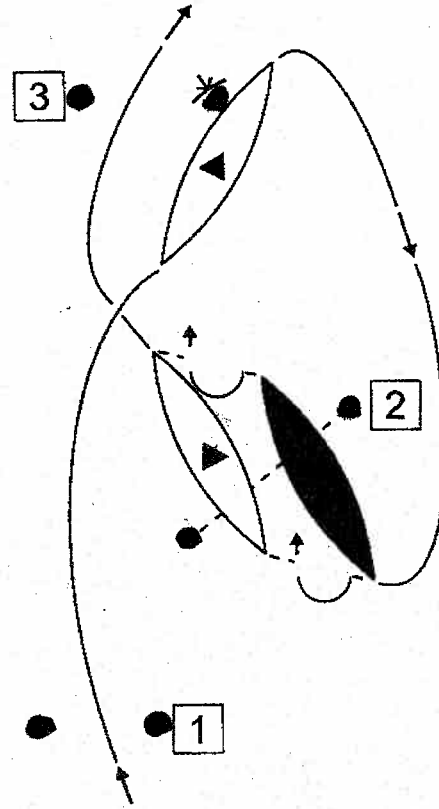

1 = 0  
 2 = 50  
 3 = 2

68 

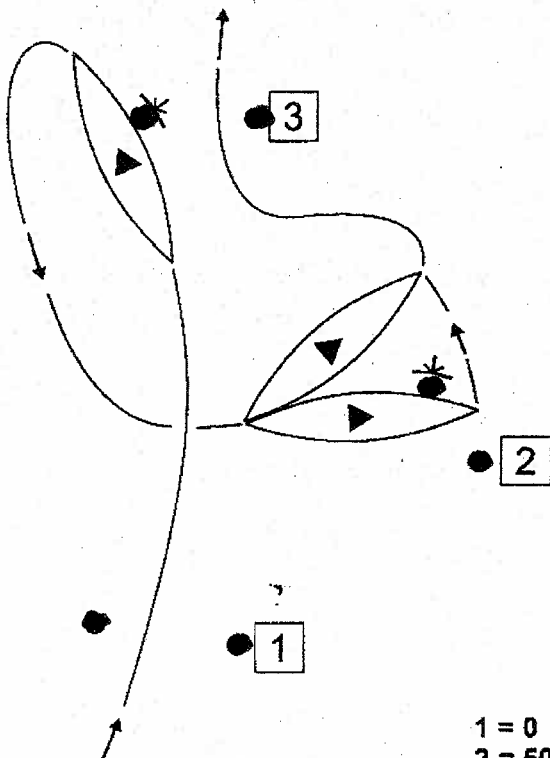

1 = 0  
 2 = 50  
 3 = 2

69 

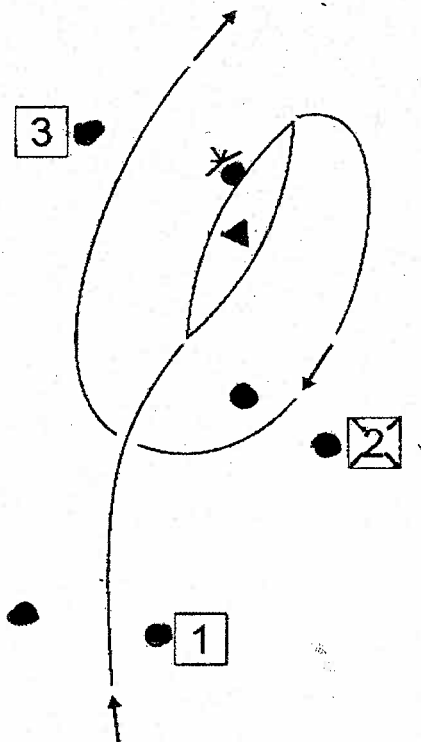

1 = 0  
 2 = 50  
 3 = 2



70

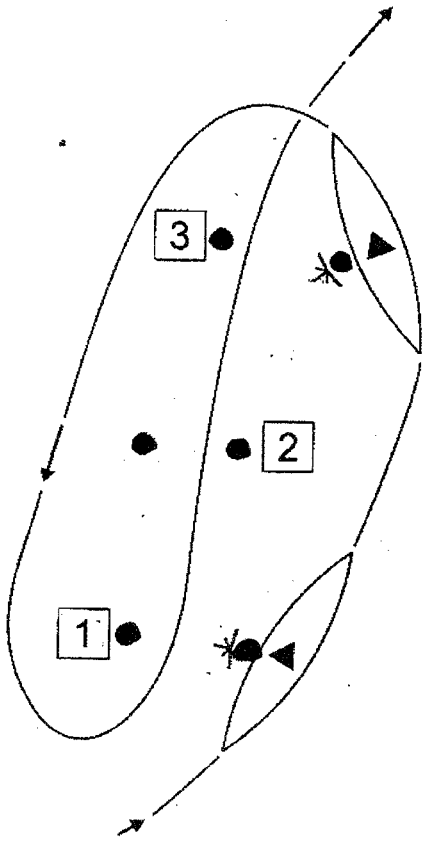

1 = 50  
 2 = 50  
 3 = 2



71

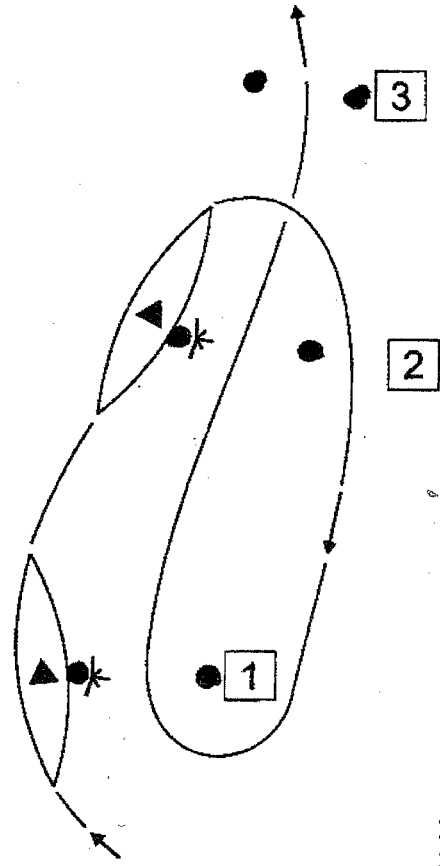

1 = 50  
 2 = 2  
 3 = 0



72

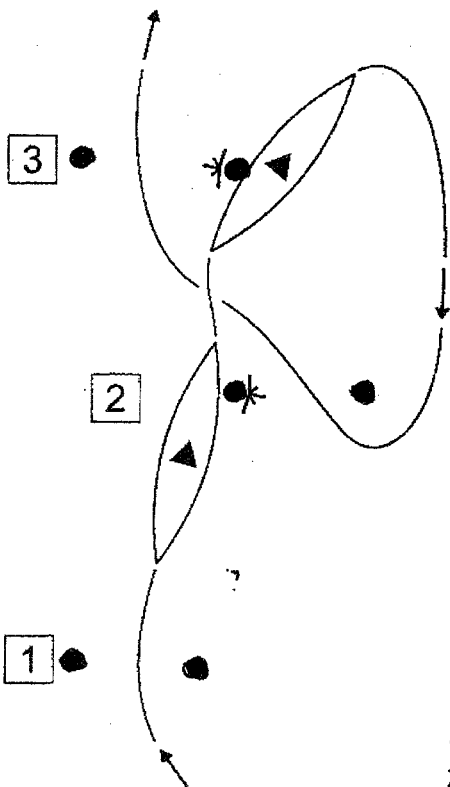

1 = 0  
 2 = 50  
 3 = 2



73

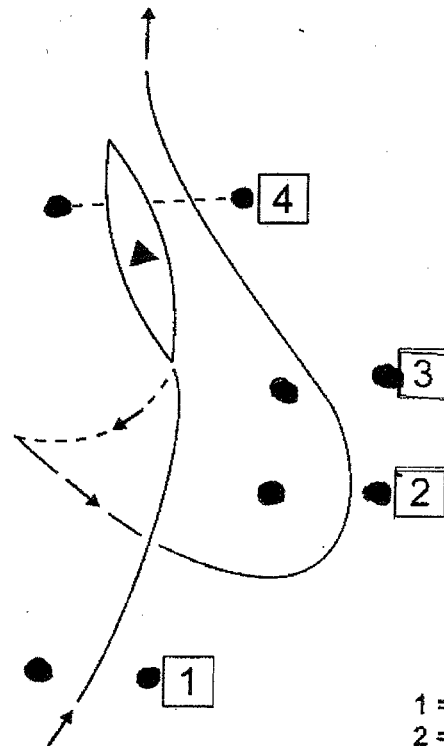

1 = 0  
 2 = 0  
 3 = 0  
 4 = 0



74

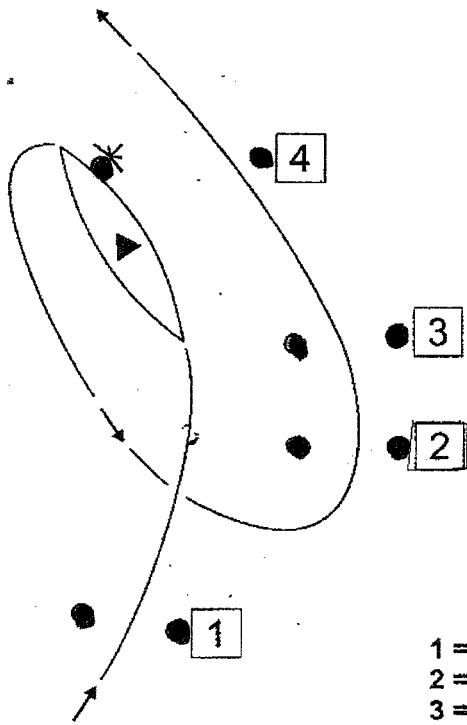

1 = 0  
 2 = 50  
 3 = 50  
 4 = 2

75

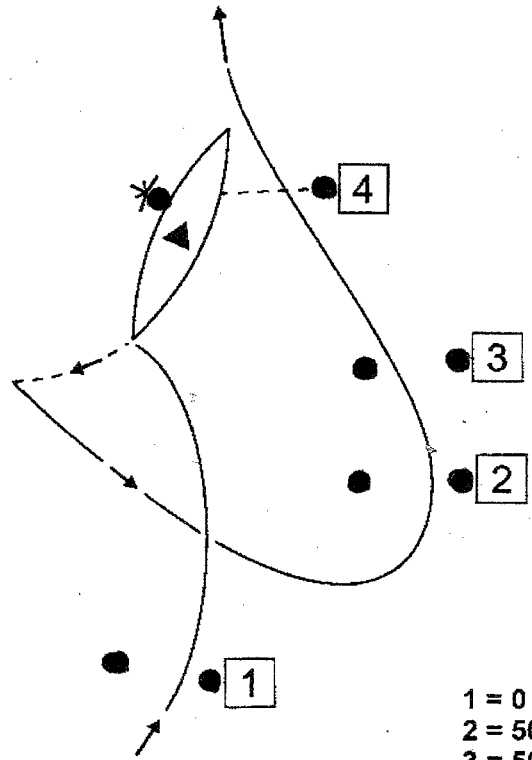

1 = 0  
 2 = 50  
 3 = 50  
 4 = 2

76

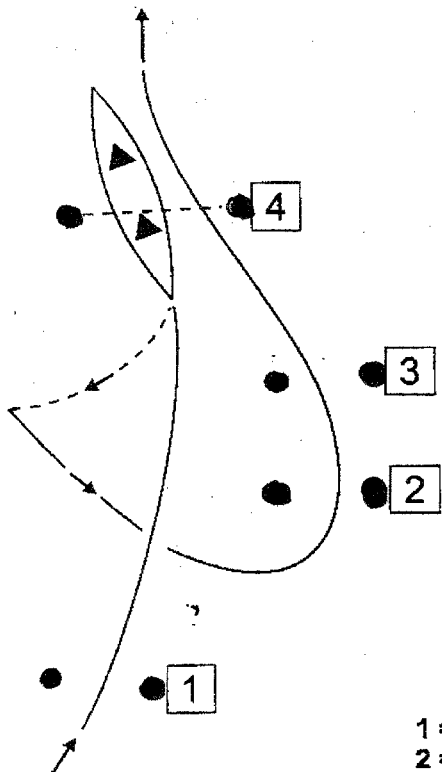

1 = 0  
 2 = 50  
 3 = 50  
 4 = 50

77

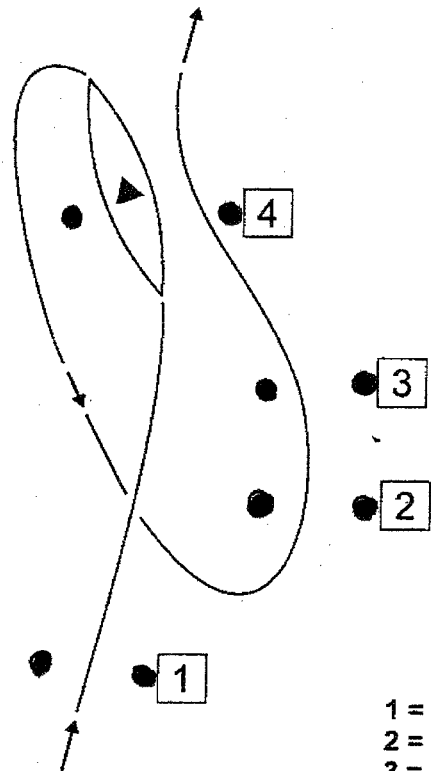

1 = 0  
 2 = 50  
 3 = 50  
 4 = 0



78

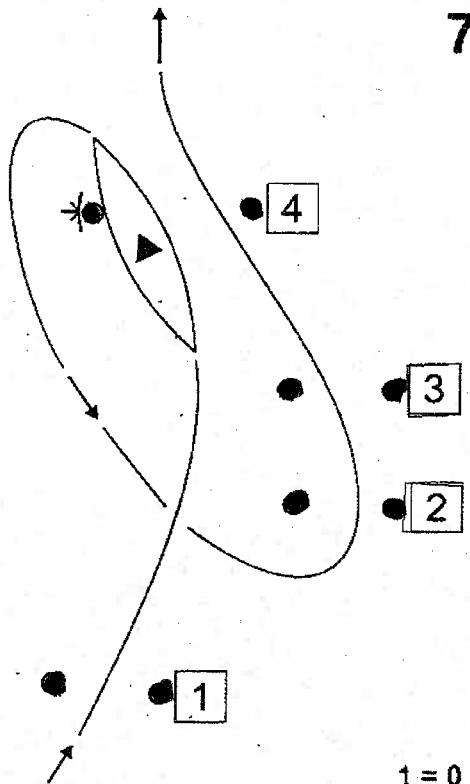

1 = 0  
 2 = 50  
 3 = 50  
 4 = 2



79

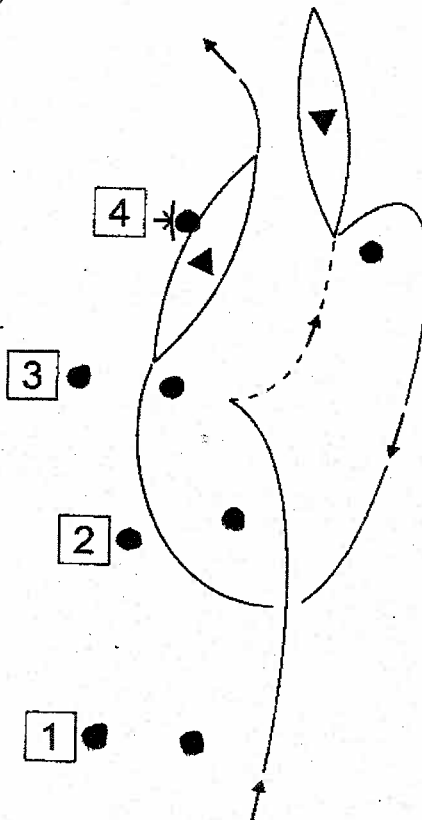

1 = 50  
 2 = 50  
 3 = 50  
 4 = 2



80

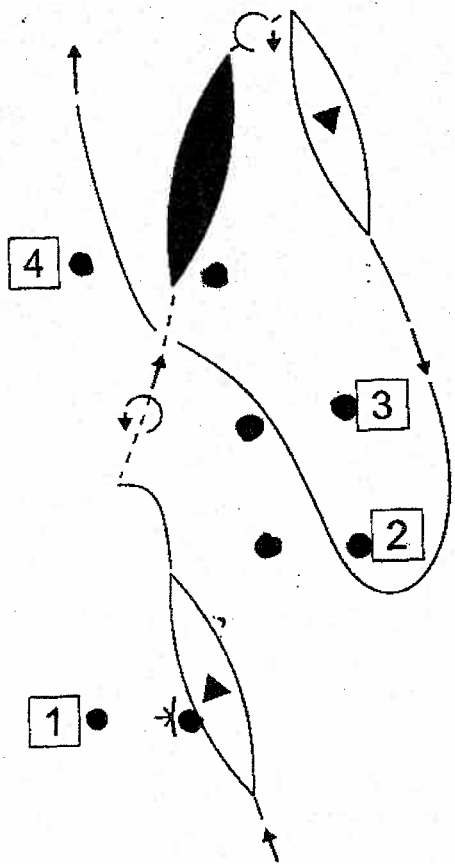

1 = 50  
 2 = 50  
 3 = 50  
 4 = 50



81

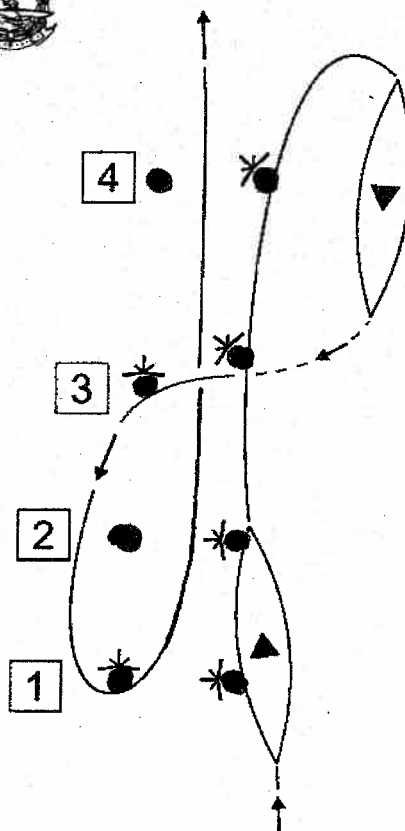

1 = 50  
 2 = 50  
 3 = 50  
 4 = 2



Eskimo roll:  
 Eskimorolle:  
 L'esquimautage:

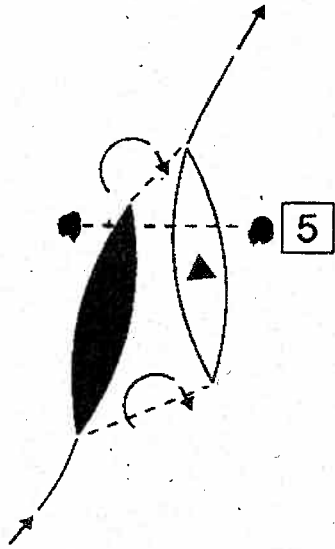

5 = 0

82

Eskimo roll:



83

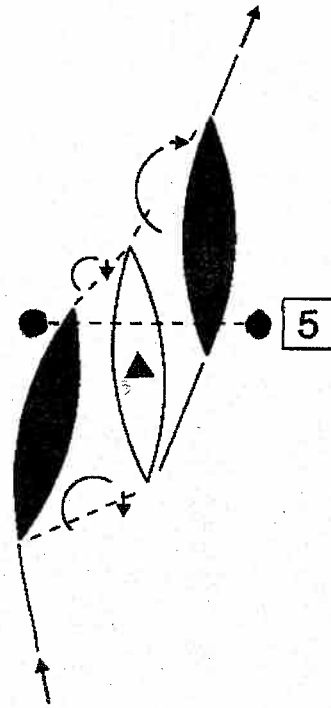

5 = 0



Eskimo roll:

84

Eskimo roll:

85

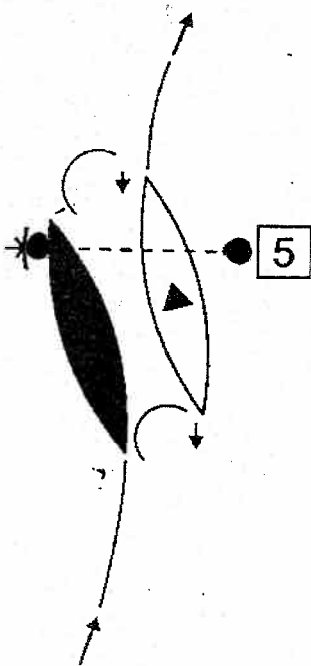

5 = 2

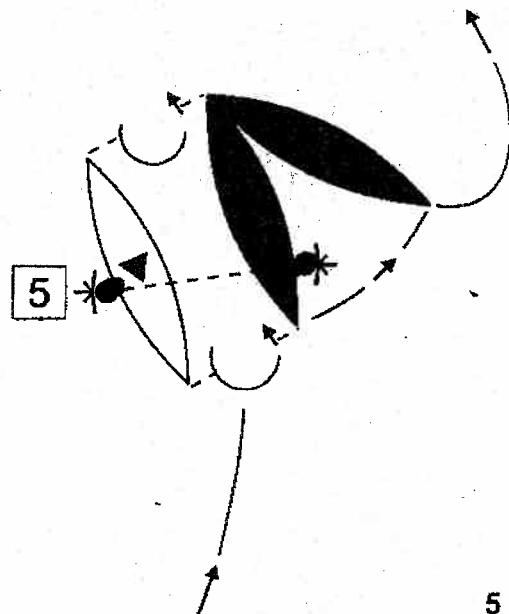

5 = 2



Eskimo roll:

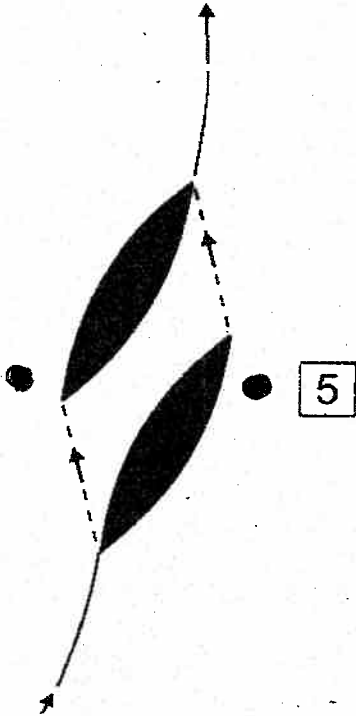

5 = 50

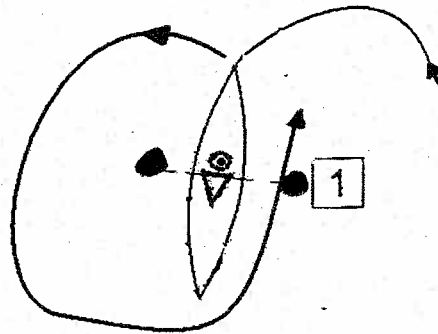
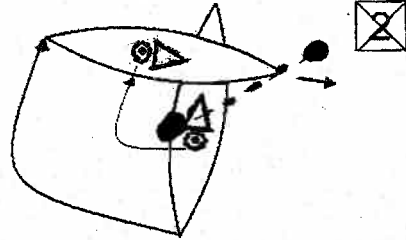

1 = 0  
2 = 0